

UWR 98

Installation and Operating Instructions

安 装 使 用 说 明

Version 2022.1



Underwater luminaires / 水下灯

9 861 04 02 UWR 98

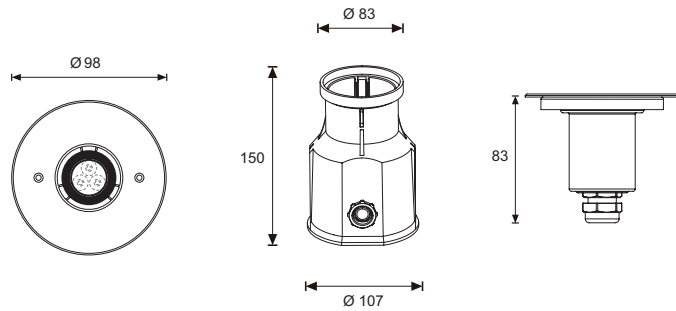

Important Information / 重要信息

1. The installation and maintenance of the product can only use the original parts, and the installation and operation of the equipment shall be subject to national and international regulations.
本产品安装和维护工作只能使用原厂配件，设备的安装和操作适用于国家和国际法规。
2. DMK is not liable for any damages resulting from improper or unskilled conduct.
DMK 不承担任何因不当或不熟练行为而造成的损害赔偿。
3. Only qualified installation personnel are allowed to assemble and install products obtained from the DMK.
只允许有安装资质的人员组装和安装从 DMK 获得的产品。
4. The contents of this manual are subject to change without prior notice. Please refer to the material in kind.
本说明书的内容如有变更，恕不另行通知。请以实物为准。
5. If in doubt, please contact the supplier.
如有疑问，请与供应商联系。

Toolings / 工具

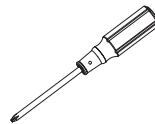

十字螺丝刀

Recommended Installation Procedure / 推荐安装过程

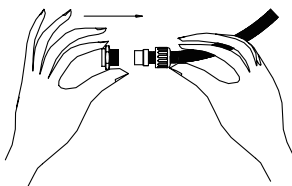

- 1-1. Put the wave tube through the nut and the rubber plug.
The wave tube should reach the bottom of the rubber plug #
将波管接通螺母和橡胶塞。波管应顶到橡胶塞底部。

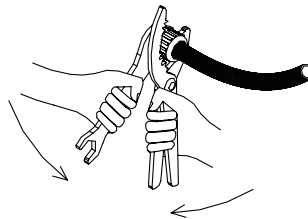

- 2-1. Fasten the nut with the screw by using a tool.
用工具将螺母拧紧。



- 3-1. Screw the PG with the connector on the wave tube tightly with two wrenches.
将防水接头扭紧在预埋桶上。

Recommended Installation Procedure / 推荐安装过程

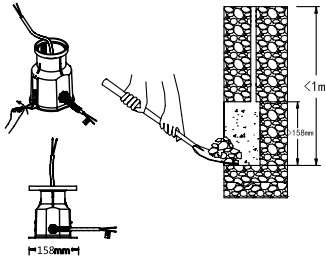

4-1. Fix the two type "L" bracket on the mounting sleeve.
将2个L型支架装在预埋桶上。

4-2. Dig a hole for the installation for each of the mounting sleeve.
The distance between these holes and the ground should less than 1m. #
挖洞以安装预埋桶，这些洞和地面的距离应少于1米。

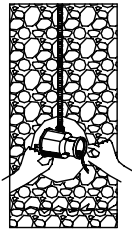

5-1. Put the mounting sleeve into the holes.
将预埋桶放进洞里。

5-2. Fasten it with the wall of the pool by a screwdriver.
用螺丝刀将其固定在水池墙上。

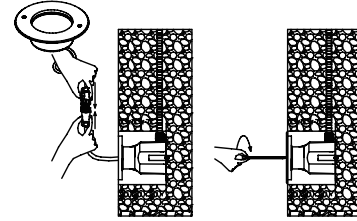
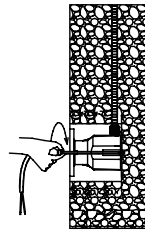

6-1. Connect the lighting fixture with the power cable by the connector.
fasten the connector tightly to make sure it can reach IP68.

用防水接头把灯具和电线连接，扭紧并固定防水接头，确保达到IP68。

6-2. Turn on the power to make sure it is working.
打开电源确保灯具正常运作。

6-3. Fix the light with the mounting sleeve by a screwdriver.
用螺丝刀将灯具固定安装在预埋桶。

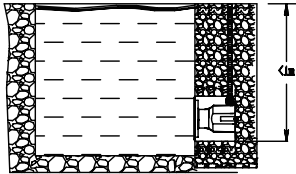

7-1. Pour the water into the pool after the installation.
安装后将水灌入水池。



- The input voltage of this product is 12/24VDC. When installing this product, follow the information labeled on the product.
此产品的输入电压为 12/24VDC，当在安装此产品时，请按照产品贴上的信息来操作。
- When using low-voltage products, please equip low-voltage 12/24VDC output switching power supply or coil transformer. The total power of all lamps combined cannot exceed 80% of the total power of the power supply. Be sure to find a qualified electrician for installation.
当使用低压产品时，请配低压 12/24VDC 输出的开关电源或线圈式的变压器。所有灯具相加的总功率不能超过电源总功率的 80%，安装时请务必找有资质的电工。
- The main material of this product is stainless steel. Due to poor thermal conductivity, please make sure to put the lamp in water before lighting it up.
这款产品的主要材料是不锈钢，由于热导率较差，使用此灯时，请确保把灯具放在水里再点亮。
- Applicable ambient temperature: less than 1 meter water depth, water temperature between $-20^{\circ}\text{C} \sim 40^{\circ}\text{C}$.
适用的环境温度为：低于 1 米水深，水温在 $-20^{\circ}\text{C} \sim 40^{\circ}\text{C}$ 之间。

Wiring Diagram / 接线图

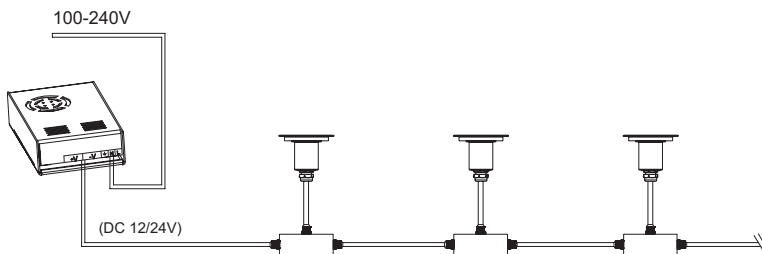

12/24VDC 灯具

