

LUNA

Installation and Operating Instructions

安 装 使 用 说 明

Version 2022.1



Pole-top luminaires / 杆顶灯
Bollards / 草坪灯

9 28x 01 xx Luna

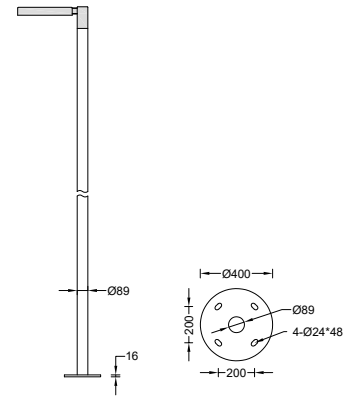
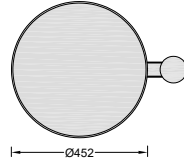
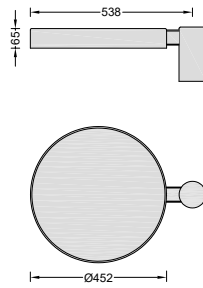

Important Information / 重要信息

1. The installation and maintenance of the product can only use the original parts, and the installation and operation of the equipment shall be subject to national and international regulations.
本产品安装和维护工作只能使用原厂配件，设备的安装和操作适用于国家和国际法规。
2. DMK is not liable for any damages resulting from improper or unskilled conduct.
DMK 不承担任何因不当或不熟练行为而造成的损害赔偿。
3. Only qualified installation personnel are allowed to assemble and install products obtained from the DMK.
只允许有安装资质的人员组装和安装从 DMK 获得的产品。
4. The contents of this manual are subject to change without prior notice. Please refer to the material in kind.
本说明书的内容如有变更，恕不另行通知。请以实物为准。
5. If in doubt, please contact the supplier.
如有疑问，请与供应商联系。

Toolings / 工具

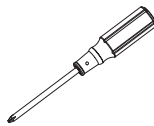

十字螺丝刀



4mm 内六角扳手



三角钥匙



30mm 开口扳手

Recommended Installation Procedure / 推荐安装过程

1. Fix the fixture on the embedded part with M20 nut and $\varnothing 20$ mm flat pad.
用 (M20 螺母、 $\varnothing 20$ 平垫) 将灯杆固定在预埋件上。



Keep the pole perpendicular to the ground.
使灯杆与地面保持垂直。

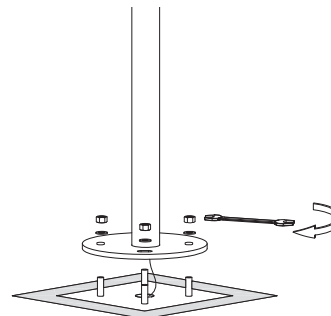

Recommended Installation Procedure / 推荐安装过程

2. Put the power Cable into pole then rotate the fixture to the appropriate position. Tighten 6-M8 screw with 4mm Hexagon socket wrench.
 将灯头电源线插入灯杆，灯头套入灯杆连接套，用 4mm 内六角扳手装 6-M8 紧定螺钉拧紧。

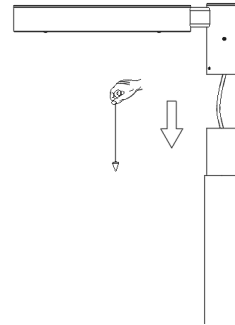

3. Open the access door with the triangle key and connect the 220V power supply.
 用三角钥匙打开灯具检修门，连接 220V 电源。

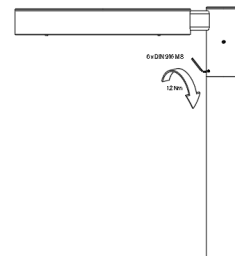

This step should be operated by professional personnel to avoid electric shock.
 此步骤需由专业人员操作，以免发生触电危险。

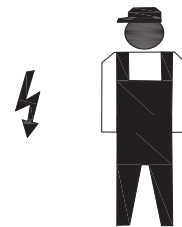
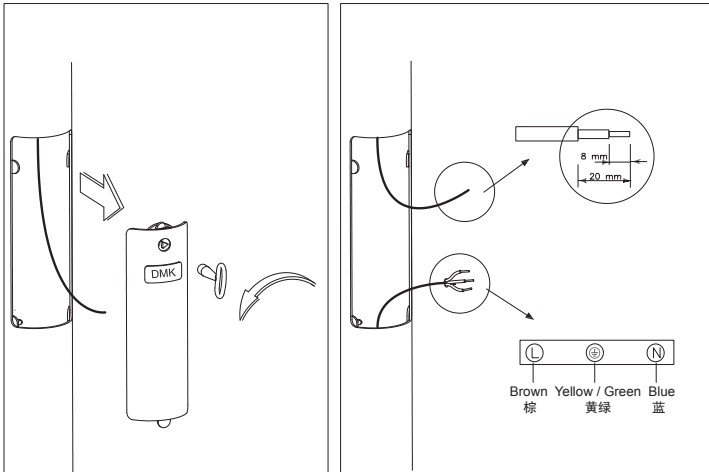

9 28x 02 xx Luna

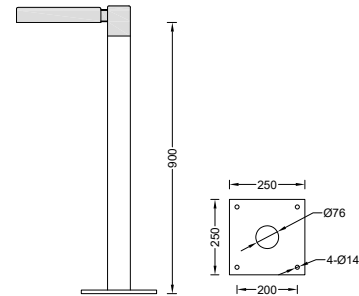
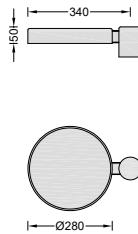

Important Information / 重要信息

- The installation and maintenance of the product can only use the original parts, and the installation and operation of the equipment shall be subject to national and international regulations.
本产品安装和维护工作只能使用原厂配件，设备的安装和操作适用于国家和国际法规。
- DMK is not liable for any damages resulting from improper or unskilled conduct.
DMK 不承担任何因不当或不熟练行为而造成的损害赔偿。
- Only qualified installation personnel are allowed to assemble and install products obtained from the DMK.
只允许有安装资质的人员组装和安装从 DMK 获得的产品。
- The contents of this manual are subject to change without prior notice. Please refer to the material in kind.
本说明书的内容如有变更，恕不另行通知。请以实物为准。
- If in doubt, please contact the supplier.
如有疑问，请与供应商联系。

Toolings / 工具

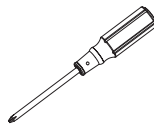

十字螺丝刀



19mm 开口扳手

Recommended Installation Procedure / 推荐安装过程

- Connect the 220V power supply.
连接 220V 电源。



Keep the pole perpendicular to the ground.
此步骤需由专业人员操作，以免发生触电危险。

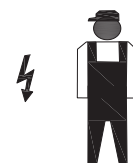
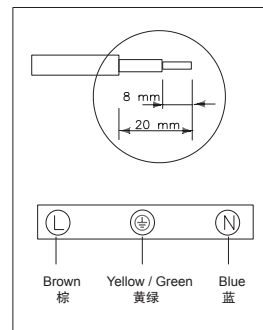

Recommended Installation Procedure / 推荐安装过程

2. Fix the fixture to the embedded part with M12 nut and \varnothing 12mm flat pad.
用 (M12 螺母、 \varnothing 12 平垫) 将灯具固定在预埋件上。



Keep the pole perpendicular to the ground.
使灯杆与地面保持垂直。

