

Installation and Operating Instructions 安 装 使 用 说 明

Version 2022.1

CE

Light building element



9 01x xx xx CE

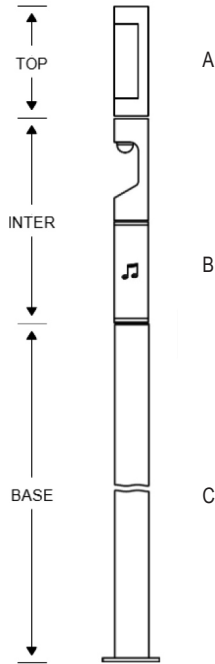

A TOP ELEMENTS / 顶部功能段

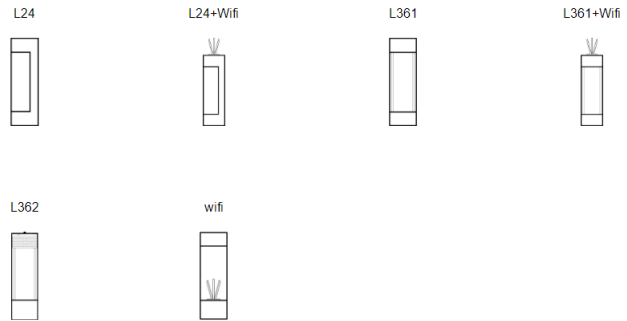

B INTER ELEMENTS / 中间功能段

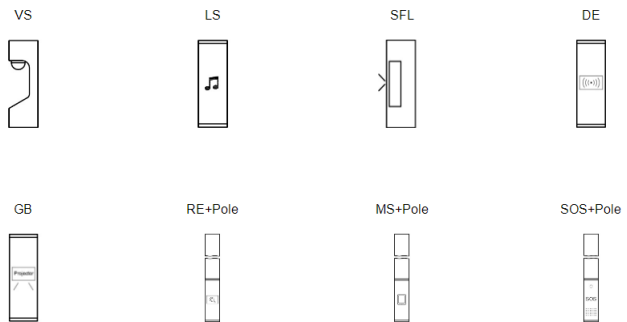

C BASE ELEMENTS / 底部功能段

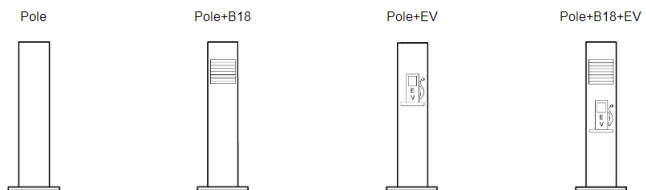

Important Information / 重要信息

1. The installation and maintenance of the product can only use the original parts, and the installation and operation of the equipment shall be subject to national and international regulations.
本产品安装和维护工作只能使用原厂配件，设备的安装和操作适用于国家和国际法规。
2. DMK is not liable for any damages resulting from improper or unskilled conduct.
DMK 不承担任何因不当或不熟练行为而造成的损害赔偿赔偿责任。
3. Only qualified installation personnel are allowed to assemble and install products obtained from the DMK.
只允许有安装资质的人员组装和安装从 DMK 获得的产品。
4. The contents of this manual are subject to change without prior notice. Please refer to the material in kind.
本说明书的内容如有变更，恕不另行通知。请以实物为准。
5. If in doubt, please contact the supplier.
如有疑问，请与供应商联系。

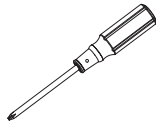
Toolings / 工具

十字螺丝刀



4/6mm 内六角扳手



三角钥匙



30mm 开口扳手

Products 产品	Dimensions 法兰尺寸	Pole flange / 灯杆法兰			Fixtue mounted / 灯头安装		
			PCS			PCS	
CE252	500×500×35mm	M24	×4	36mm	M8	×6	4mm
CE230	400×400×30mm	M20	×4	30mm	M8	×6	4mm
CE200	300×300×20mm	M20	×4	30mm	M8	×3	4mm
CE184	250×250×20mm	M20	×4	30mm	M8	×3	4mm
CE150	250×250×12mm	M20	×4	30mm	-	-	-

Recommended Installation Procedure / 推荐安装过程

1. Fix the pole on the embedded part.
灯杆固定在预埋件上。



Keep the pole perpendicular to the ground.
使灯杆与地面保持垂直。

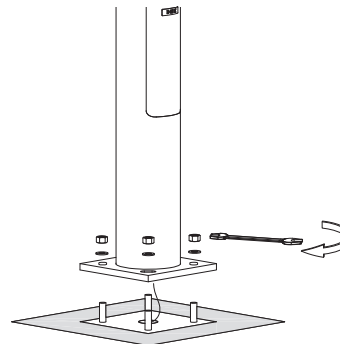

2. Connect the plug terminal of the power cord, put the fixture on the pole and rotate it to the appropriate position.
Tighten screw.
将灯头插入灯杆，电源线对插端子连接，旋转至合适的位置固定灯头。

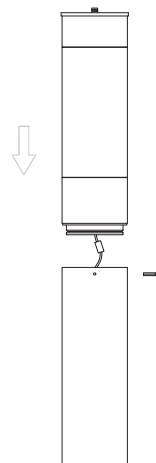

Recommended Installation Procedure / 推荐安装过程

3. Open the access door with the triangle key and connect the 220V power supply.
用三角钥匙打开灯具检修门，连接 220V 电源。



This step should be operated by professional personnel to avoid electric shock.
此步骤需由专业人员操作，以免发生触电危险。

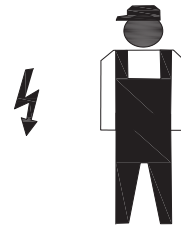
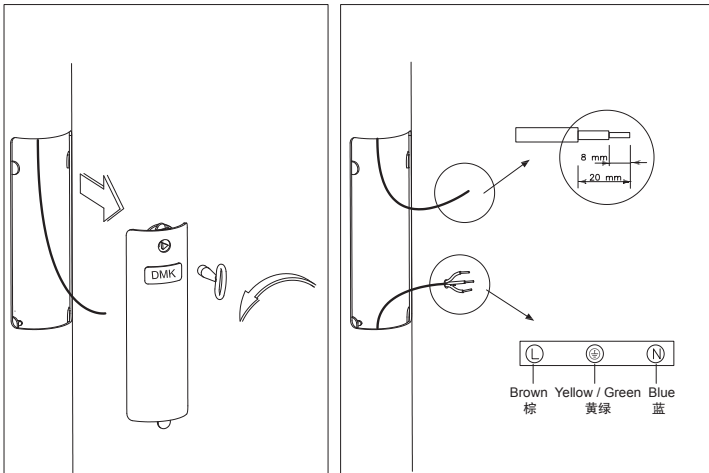

Toolings / 工具

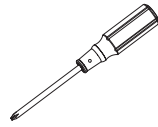

十字螺丝刀



三角钥匙



19mm 开口扳手

Recommended Installation Procedure / 推荐安装过程

1. Fix the fixture to the embedded part with M12 nut and \varnothing 12mm flat pad.
用 (M12 螺母、 \varnothing 12 平垫) 将灯具固定在预埋件上。

2. Open the access door with the triangle key and connect the 220V power supply.
用三角钥匙打开灯具检修门，连接 220V 电源。



This step should be operated by professional personnel to avoid electric shock.
此步骤需由专业人员操作，以免发生触电危险。

